

Metalen randkist

Geprofileerde metalen randkist voor gestorte vloerconstructies (breedplaat/kanaalplaat/combinatievloer). Het systeem is licht in gewicht en wordt geplaatst op binnenspouwbladen en woningscheidende muren. De universele hoekstukken en spanners maken het systeem compleet. De Metalen randkist is een 'verloren' bekisting, waardoor ontkisten niet meer nodig is. Leverbaar in verschillende hoogtematen dus geschikt voor vrijwel elke vloerdikte.

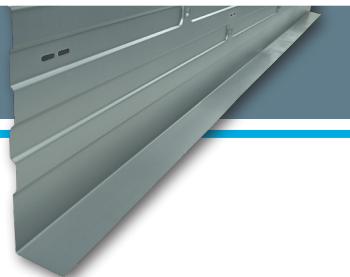

Artikel Informatie

	Vloerhoogte mm	Lengte mm	Dikte mm	Staalkwaliteit	Opp	Art. nr.	Hoekstuk Art. nr.
Metalen randkist geprofileerd	150	2000	0,75	DX51	SV - 1	103150	103015
	160	2000	0,75	DX51	SV - 1	103160	103015
	170	2000	0,75	DX51	SV - 1	103170	103015
	180	2000	0,75	DX51	SV - 1	103180	103015
	190	2000	0,75	DX51	SV - 1	103190	103015
	200	2000	0,75	DX51	SV - 1	103200	103015
	210	2000	0,75	DX51	SV - 1	103210	103015
	220	2000	0,75	DX51	SV - 1	103220	103021
	230	2000	0,75	DX51	SV - 1	103230	103021
	240	2000	0,75	DX51	SV - 1	103240	103021
	250	2000	0,75	DX51	SV - 1	103250	103021
	260	2000	0,75	DX51	SV - 1	103260	103025
	270	2000	0,75	DX51	SV - 1	103270	103025
	280	2000	0,75	DX51	SV - 1	103280	103025
	290	2000	0,75	DX51	SV - 1	103290	103025
	300	2000	0,75	DX51	SV - 1	103300	103025
	310	2000	0,75	DX51	SV - 1	103310	103030
	320	2000	0,75	DX51	SV - 1	103320	103030
	330	2000	0,75	DX51	SV - 1	103330	103030
	340	2000	0,75	DX51	SV - 1	103340	103030
350	2000	0,75	DX51	SV - 1	103350	103030	

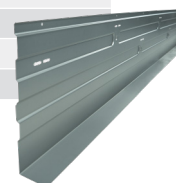

	Vloerhoogte mm	Lengte mm	Dikte mm	Staalkwaliteit	Opp	Gatenpatroon aantal/mm	Art. nr. 84°
84° in de haak gezet	150	2000	1,5	DX51	SV - 1	8/7	107150
	180	2000	1,5	DX51	SV - 1	8/7	107180
	200	2000	1,5	DX51	SV - 1	8/7	107200
	210	2000	1,5	DX51	SV - 1	8/7	107210
	220	2000	1,5	DX51	SV - 1	8/7	107220
	230	2000	1,5	DX51	SV - 1	8/7	107230
	240	2000	1,5	DX51	SV - 1	8/7	107240
	250	2000	1,5	DX51	SV - 1	8/7	107250

2 mm op aanvraag leverbaar

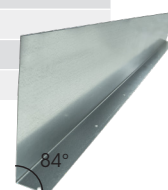

	Vloerhoogte mm	Lengte mm	Dikte mm	Staalkwaliteit	Opp	Gatenpatroon aantal/mm	Art. nr. 90°
Metalen randkist 90° vlak	230	2000	1,5	DX51	SV - 1	4/5-8/7	113230
	240	2000	1,5	DX51	SV - 1	4/5-8/7	113240
	260	2000	1,5	DX51	SV - 1	4/5-8/7	113260
	280	2000	1,5	DX51	SV - 1	4/5-8/7	113280
	300	2000	1,5	DX51	SV - 1	4/5-8/7	113300
	320	2000	1,5	DX51	SV - 1	4/5-8/7	113320
	340	2000	1,5	DX51	SV - 1	4/5-8/7	113340
	360	2000	1,5	DX51	SV - 1	4/5-8/7	113360
380	2000	1,5	DX51	SV - 1	4/5-8/7	113380	

2 mm op aanvraag leverbaar

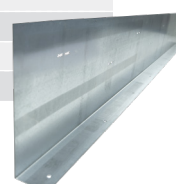

Stap voor stap metalen randkist geprofileerd

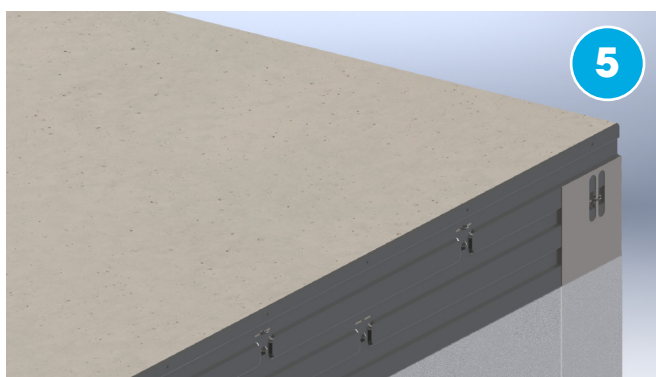
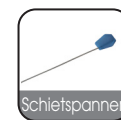
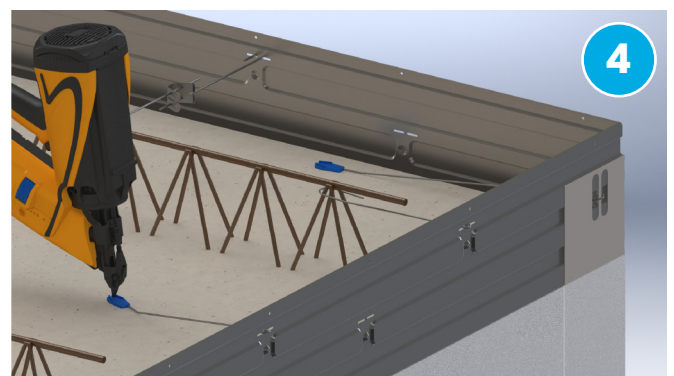
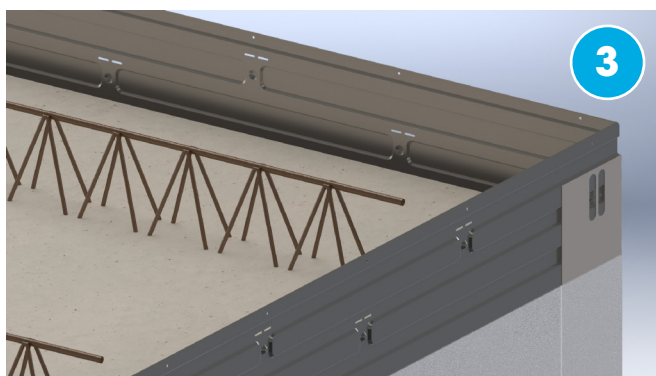
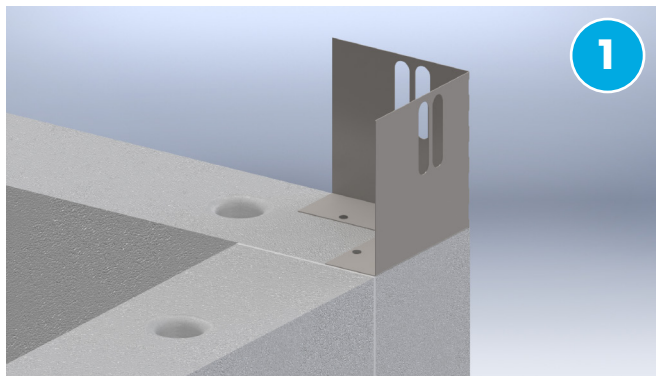

Combinatie mogelijkheden

